













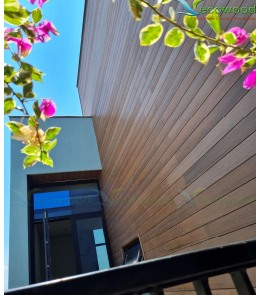

BẢO GIÁ GỖ NHỰA COMPOSITE ECOWOOD 2021

(Bảng giá chưa bao gồm 10% VAT)

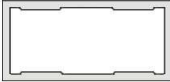
Xin trân trọng cảm ơn Quý khách đã quan tâm và sẽ sử dụng Hàng hoá - Sản phẩm- Dịch vụ của chúng tôi.
 Chúng tôi xin hân hạnh gửi tới quý khách bảng báo giá cho các sản phẩm gỗ nhựa Composite Ecowood như sau:

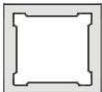
STT	Mã sản phẩm	Hình ảnh sản phẩm	Mặt cắt sản phẩm	Quy cách (W)*(H)mm	Ứng dụng	Đơn giá bán lẻ		Ghi chú
						Vnd/mét	Vnd/m2	
VẬT LIỆU: GỖ NHỰA COMPOSITE NGUYÊN SINH DÒNG 2 LỚP (PVC + GỖ NGUYÊN SINH)								
THẺ MÀU GỖ NHỰA NGUYÊN SINH 2 LỚP								
								
		Gold	Golden Teak	Brown Teak	Walnut	Boat Wood		
								
I - TẤM ÓP TRẦN - ÓP TƯỜNG 2 LỚP CAO CẤP (NHỰA PVC + GỖ NGUYÊN SINH + PVDF/ASA)								
1	WPO-23728CD (Dòng 2 lớp, bề mặt 3D)	 Model: WPO-23728CD Wall & Ceiling Size: 237*28mm		KT: 237*28 Độ dài thanh: L=3.9m (PVC + Gỗ nguyên sinh + Bề mặt 3D phủ PVDF/ASA, chống tia UV)	Óp tường, ốp trần trang trí nội ngoại thất, không cần sơn PU bảo vệ	230,769	1,048,951	

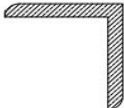
2	WPO-10016CD (Dòng 2 lớp, bề mặt 3D)	 Model Wall & Ceiling WPO-10016CD Size: 115*16mm		KT: 115*16 Độ dài thanh: L=3.9m (PVC + Gỗ nguyên sinh + Bề mặt 3D phủ PVDF/ASA, chống tia UV)	Ốp tường, ốp trần trang trí nội ngoại thất, không cần sơn PU bảo vệ	80,886	808,862	
3	FSO-100CD (Dòng 2 lớp, bề mặt 2D)	 Model Multipurpose FSO-100CD Size: 100*50mm		KT: 100*50 Độ dài thanh: L=3.9m (PVC + Gỗ nguyên sinh + Bề mặt 2D phủ PVDF/ASA, chống tia UV)	Lam chắn nắng, giàn hoa, cổng, lan can, hàng rào, lam trần, lam tường, không cần sơn PU bảo vệ	184,615		
4	FSO-50CD (Dòng 2 lớp, bề mặt 2D)	 Model Multipurpose FSO-50CD Size: 50*50mm		KT: 50*50 Độ dài thanh: L=3.9m (PVC + Gỗ nguyên sinh + Bề mặt 2D phủ PVDF/ASA, chống tia UV)	Lam chắn nắng, giàn hoa, cổng, lan can, hàng rào, lam trần, lam tường	98,462		
5	E45CD (Dòng 2 lớp, bề mặt 2D)	 Model Splins E45CD Size: 45*45mm		KT: 45*45 Độ dài thanh: L=3.9m (PVC + Gỗ nguyên sinh + Bề mặt 2D phủ PVDF/ASA, chống tia UV)	Nẹp góc cạnh tấm ốp dòng CD có phủ PVDF, nguyên sinh	48,108		

VẬT LIỆU: GỖ NHỰA COMPOSITE NGUYÊN SINH DÒNG 1 LỚP (PVC + GỖ NGUYÊN SINH)

THẺ MÀU GỖ NHỰA NGUYÊN SINH ECOWOOD



CEDAR

WHITE OAK

TEAK

CHERRY

RED TEAK

WALNUT











BLACK WALNUT





BAMBOO

MAHOGANY





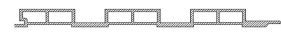

GRAY



II - TẤM ỐP TRẦN - ỐP TƯỜNG NAN KÈ 1 LỚP (NHỰA PVC + GỖ NGUYÊN SINH)

6	QBI-05	 <p>Model QBI-05</p> <p>Wall & Ceiling Size: 159*10mm</p>		<p>KT: 159*10 Độ dài thanh: L=2.9m & 5.8m</p>	Ốp tường, ốp trần trang trí nội ngoại thất	59,231	394,872	
7	QBI-08	 <p>Model QBI-08</p> <p>Wall & Ceiling Size: 169*13mm</p>		<p>KT: 169*13 Độ dài thanh: L=2.9m & 5.8m</p>	Ốp tường, ốp trần trang trí nội ngoại thất	82,354	514,712	
8	QBO-37B	 <p>Model QBO-37B</p> <p>Wall & Ceiling Size: 130*26mm</p>		<p>KT: 130*26 Độ dài thanh: L=2.9m & 5.8m</p>	Ốp tường, ốp trần trang trí nội ngoại thất	86,105	717,538	
9	QBO-37C	 <p>Model QBO-37C</p> <p>Wall & Ceiling Size: 150*25mm</p>		<p>KT: 150*25 Độ dài thanh: L=2.9m & 5.8m</p>	Ốp tường, ốp trần trang trí nội ngoại thất	95,400	636,000	
10	QBO-38	 <p>Model QBO-38</p> <p>Wall & Ceiling Size: 168*25mm</p>		<p>KT: 168*25 Độ dài thanh: L=2.9m & 5.8m</p>	Ốp tường, ốp trần trang trí nội ngoại thất	101,108	652,308	
11	QBI-22	 <p>Model QBI-22</p> <p>Wall & Ceiling Size: 204*30mm</p>		<p>KT: 204*30 Độ dài thanh: L=2.9m & 5.8m</p>	Ốp tường, ốp trần trang trí nội ngoại thất	145,138	744,300	





12	WPO-148	 <p>Model Wall & Ceiling WPO-148 Size: 148*13.5mm</p>		KT: 148*13.5 Độ dài thanh: L=2.9m & 5.8m	Óp tường, ốp trần trang trí nội ngoại thất	86,757	619,692	
13	WPO-169	 <p>Model Wall - Ceiling WPO-169 Size: 169*15mm</p>		KT: 169*15 Độ dài thanh: L=2.9m & 5.8m	Óp tường, ốp trần trang trí nội ngoại thất	105,022	656,385	
14	WPO-202	 <p>Model Wall & Ceiling WPO-202 Size: 202*15mm</p>		KT: 202*15 Độ dài thanh: L=2.9m & 5.8m	Óp tường, ốp trần trong nhà, ngoài nhà	94,585	472,923	

III - TẤM ỐP TRẦN - ỐP TƯỜNG PHẪNG 1 LỚP (NHỰA PVC + GỖ NGUYÊN SINH)

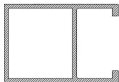

15	WPO-109	 <p>Model Wall & Ceiling WPO-109 Size: 109*10mm</p>		KT: 109*10 Độ dài thanh: L=2.9m & 5.8m	Óp tường, ốp trần trang trí nội ngoại thất	46,477	464,769	
16	WPO-10016	 <p>Model Wall & Ceiling WPO-10016 Size: 115*16mm</p>		KT: 115*16 Độ dài thanh: L=2.9m & 5.8m	Óp tường, ốp trần trang trí nội ngoại thất	73,385	733,846	
17	WPO-12009	 <p>Model Wall & Ceiling WPO-12009 Size: 135*09mm</p>		KT: 135*09 Độ dài thanh: L=2.9m & 5.8m	Óp tường, ốp trần trang trí nội ngoại thất	68,492	570,769	

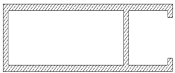





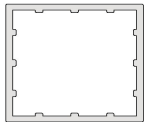

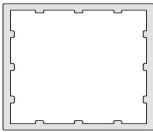

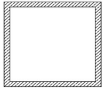
18	WPO-125	 <p>Model Wall & Ceiling WPO-125 Size: 125*12mm</p>		KT: 125*12 Độ dài thanh: L=2.9m & 5.8m	Ốp tường, ốp trần trang trí nội ngoại thất	62,295	587,692	
----	---------	---	---	---	--	---------------	----------------	--







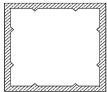



IV - TRẦN NAN 1 LỚP (NHỰA PVC + GỖ NGUYÊN SINH)



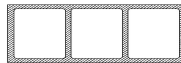

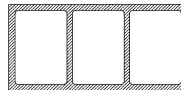

19	CLI-5540	 <p>Model Louver CLI-5540 Size: 55*40mm</p>		KT: 55*40 Độ dài thanh: L=2.9m & 5.8m	Trần nan, ốp tường trang trí	48,923		
20	CLI-8040	 <p>Model Louver CLI-8040 Size: 80*40mm</p>		KT: 80*40 Độ dài thanh: L=2.9m & 5.8m	Trần nan, ốp tường trang trí	75,015		
21	CLI-10040	 <p>Model Louver CLI-10040 Size: 100*40mm</p>		KT: 100*40 Độ dài thanh: L=2.9m & 5.8m	Trần nan, ốp tường trang trí	84,800		

V - HỆ LAM TRANG TRÍ - PERGOLAS - LAN CAN - HÀNG RÀO - CHÒI NGHỈ - VẬT DỤNG 1 LỚP (NHỰA PVC + GỖ NGUYÊN SINH)

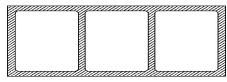

22	PSO-100	 <p>Model Post PSO-100 Size: 100*100mm</p>		KT: 100*100 Độ dài thanh: L=2.9m & 5.8m	Cột, dầm, lam chắn nắng	363,662		
23	PSO-120	 <p>Model Post PSO-120 Size: 120*120mm</p>		KT: 120*120 Độ dài thanh: L=2.9m & 5.8m	Cột, dầm, lam chắn nắng	399,538		

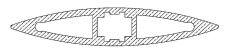
24	FSO-35	 <p>Model Multipurpose FSO-35 Size: 35*35mm</p>		<p>KT: 35*35 Độ dài thanh: L=2.9m & 5.8m</p>	Lam chắn nắng, giàn hoa, cổng, lan can, hàng rào, lam trần, lam tường	68,492		
25	FSO-4025	 <p>Model Multipurpose FSO-4025 Size: 40*25mm</p>		<p>KT: 40*25 Độ dài thanh: L=2.9m & 5.8m</p>	Lam chắn nắng, giàn hoa, cổng, lan can, hàng rào, lam trần, lam tường	52,185		
26	FSO-4050	 <p>Model Multipurpose FSO-4050 Size: 40*50mm</p>		<p>KT: 40*50 Độ dài thanh: L=2.9m & 5.8m</p>	Lam chắn nắng, giàn hoa, cổng, lan can, hàng rào, lam trần, lam tường	71,754		
27	FSO-5025	 <p>Model Multipurpose FSO-5025 Size: 50*25mm</p>		<p>KT: 50*25 Độ dài thanh: L=2.9m & 5.8m</p>	Lam chắn nắng, giàn hoa, cổng, lan can, hàng rào, lam trần, lam tường	70,123		
28	FSO-50	 <p>Model Louver FSO-50 Size: 50*50mm</p>		<p>KT: 50*50 Độ dài thanh: L=2.9m & 5.8m</p>	Lam chắn nắng, giàn hoa, cổng, lan can, hàng rào, lam trần, lam tường	75,015		
29	FSO-6525	 <p>Model Louver FSO-6525 Size: 65*25mm</p>		<p>KT: 65*25 Độ dài thanh: L=2.9m & 5.8m</p>	Lam chắn nắng, giàn hoa, cổng, lan can, hàng rào, lam trần, lam tường	75,015		

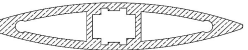
30	FSO-7550	 <p>Model Multipurpose FSO-7550 Size: 75*50mm</p>		<p>KT: 75*50 Độ dài thanh: L=2.9m & 5.8m</p>	Lam chắn nắng, giàn hoa, cổng, lan can, hàng rào, lam trần, lam tường	114,154		
31	FSO-10025	 <p>Model Multipurpose FSO-10025 Size: 100*25mm</p>		<p>KT: 100*25 Độ dài thanh: L=2.9m & 5.8m</p>	Lam chắn nắng, giàn hoa, cổng, lan can, hàng rào, lam trần, lam tường	120,677		
32	FSO-10035	 <p>Model Multipurpose FSO-10035 Size: 100*35mm</p>		<p>KT: 100*35 Độ dài thanh: L=2.9m & 5.8m</p>	Lam chắn nắng, giàn hoa, cổng, lan can, hàng rào, lam trần, lam tường	127,200		
33	FSO-100	 <p>Model Louver FSO-100 Size: 100*50mm</p>		<p>KT: 100*50 Độ dài thanh: L=2.9m & 5.8m</p>	Lam chắn nắng, giàn hoa, cổng, lan can, hàng rào, lam trần, lam tường	161,538		
34	FSO-100B	 <p>Model Multipurpose FSO-100B Size: 100*50mm</p>		<p>KT: 100*50 Độ dài thanh: L=2.9m & 5.8m</p>	Lam chắn nắng, giàn hoa, cổng, lan can, hàng rào, lam trần, lam tường	146,154		
35	FSO-15035	 <p>Model Multipurpose FSO-15035 Size: 150*35mm</p>		<p>KT: 150*35 Độ dài thanh: L=2.9m & 5.8m</p>	Lam chắn nắng, giàn hoa, cổng, lan can, hàng rào, lam trần, lam tường	234,831		

36	FSO-150	 Model: FSO-150 Louver Size: 150*50mm		KT: 150*50 Độ dài thanh: L=2.9m & 5.8m	Lam chắn nắng, giàn hoa, cổng, lan can, hàng rào, lam trần, lam tường	244,615		
37	FSO-150B	 Model: FSO-150B Multipurpose Size: 150*50mm		KT: 150*50 Độ dài thanh: L=2.9m & 5.8m	Lam chắn nắng, giàn hoa, cổng, lan can, hàng rào, lam trần, lam tường	260,923		
39	LPO-9018	 Model: LPO-9018 Louver Size: 90*18mm		KT: 90*18 Độ dài thanh: L=2.9m & 5.8m	Lam chắn nắng, giàn hoa, lan can, hàng rào, lam trần, lam tường. Lam chớp xoay, lam chớp cố định	73,385		
40	LPO-15238	 Model: LPO-15238 Louver Size: 152*38mm		KT: 152*38 Độ dài thanh: L=2.9m & 5.8m	Lam chắn nắng, giàn hoa, lan can, hàng rào, lam trần, lam tường. Lam chớp xoay, lam chớp cố định	203,846		

VI - SÀN GỖ NGOÀI TRỜI NGUYÊN SINH 1 LỚP (NHỰA PVC + GỖ NGUYÊN SINH)

41	DBO-140	 Model: DBO-140 Decking Size: 140*25mm		KT: 140*25 Độ dài thanh: L=2.9m	Lót sàn hồ bơi, cafe ngoài trời, lan can, cầu cảng, sân vườn, hành lang, sân thượng, ốp vách, ốp trần, ốp tường, ốp cửa cổng	164,382	1,174,154	
----	----------------	---	---	--	--	----------------	------------------	--

VẬT LIỆU: GỖ NHỰA COMPOSITE HDPE (HDPE + GỖ)

THẺ MÀU GỖ NHỰA HDPE ECOWOOD



CEDAR

BROWN

WOOD

SANDAL WOOD







COFFEE

GRAY



DARK GREY







MOCHA

I - SÀN GỖ NGOÀI TRỜI MỘT LỚP (NHỰA HDPE + GỖ)





42	EW-R01	 <p>Model Decking EW-R01 Size: 140*25mm</p>		<p>KT: 140*25 Độ dài thanh: L=2.2m & L=2.9m</p>	<p>Lót sàn hồ bơi, cafe ngoài trời, lan can, cầu cảng, sân vườn, hành lang, sân thượng, ốp vách, ốp trần, ốp tường, ốp cửa công</p>	110,769	791,209	
43	EW-R01B	 <p>Model Decking EW-R01B Size: 140*25mm</p>		<p>KT: 140*25 Độ dài thanh: L=2.2m & L=2.9m</p>	<p>Lót sàn hồ bơi, cafe ngoài trời, lan can, cầu cảng, sân vườn, hành lang, sân thượng, ốp vách, ốp trần, ốp tường, ốp cửa công</p>	108,462	774,725	
44	EW-D03	 <p>Model Decking EW-D03 Size: 140*25mm</p>		<p>KT: 140*25 Độ dài thanh: L=2.2m & L=2.9m</p>	<p>Lót sàn hồ bơi, cafe ngoài trời, lan can, cầu cảng, sân vườn, hành lang, sân thượng, ốp vách, ốp trần, ốp tường, ốp cửa công</p>	203,077	1,450,549	

II- SÀN GỖ NGOÀI TRỜI MỘT LỚP (NHỰA HDPE + GỖ)



45	EW-3D01	 <p>Model Decking EW-3D01 Size: 145*21mm</p>		<p>KT: 145*21 Độ dài thanh: L=2.9m</p>	<p>Lót sàn hồ bơi, cafe ngoài trời, lan can, cầu cảng, sân vườn, hành lang, sân thượng, ốp vách, ốp trần, ốp tường, ốp cửa công</p>	138,831	957,454	
----	---------	---	---	---	---	---------	---------	--

46	EW-3D02	 <p>Model Decking EW-3D02 Size: 140*24mm</p>		KT: 140*24 Độ dài thanh: L=2.9m	Lót sàn hồ bơi, cafe ngoài trời, lan can, cầu cảng, sân vườn, hành lang, sân thượng, ốp vách, ốp trần, ốp tường, ốp cửa công	143,692	1,026,374	
47	EW-3D03	 <p>Model Decking EW-3D03 Size: 146*24mm</p>		KT: 146*24 Độ dài thanh: L=2.9m	Lót sàn hồ bơi, cafe ngoài trời, lan can, cầu cảng, sân vườn, hành lang, sân thượng, ốp vách, ốp trần, ốp tường, ốp cửa công	142,538	976,291	
48	EW-3D05	 <p>Model Decking EW-3D05 Size: 146*25mm</p>		KT: 146*25 Độ dài thanh: L=2.9m	Lót sàn hồ bơi, cafe ngoài trời, lan can, cầu cảng, sân vườn, hành lang, sân thượng, ốp vách, ốp trần, ốp tường, ốp cửa công	156,923	1,074,816	

III - SÀN GỖ NGOÀI TRỜI HAI LỚP (HDPE + GỖ + BỀ MẶT PHỦ FVDF VÂN GỖ UV)







49	EW-C01 (Dòng 2 lớp, bề mặt 3D)	 <p>Model Decking EW-C01 Size: 138*23mm</p>		KT: 138*23 Độ dài thanh: L=2.9m	Lót sàn hồ bơi, cafe ngoài trời, lan can, cầu cảng, sân vườn, hành lang, sân thượng, ốp vách, ốp trần, ốp tường, ốp cửa công	198,204	1,436,259	
50	EW-C02 (Dòng 1 lớp, bề mặt 3D)	 <p>Model Decking EW-C02 Size: 138*23mm</p>		KT: 138*23 Độ dài thanh: L=2.9m	Lót sàn hồ bơi, cafe ngoài trời, lan can, cầu cảng, sân vườn, hành lang, sân thượng, ốp vách, ốp trần, ốp tường, ốp cửa công	255,313	1,850,096	

V - THANH ĐA NĂNG (HDPE + GỖ)



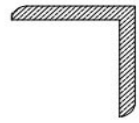

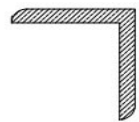

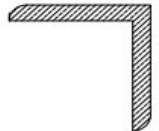





51	142H10-3D	 Model Multipurpose 142H10-3D Size: 142*10mm		KT: 142*10 Độ dài thanh: L=2.2m & L=2.9m	Thanh đa năng: Lan can, hàng rào, trang trí sân vườn, hành lang, sân thượng, ốp vách, ốp trần, ốp tường, ốp cửa cổng.	135,385	967,033	
----	-----------	--	---	---	---	---------	---------	--

PHỤ KIỆN LẮP ĐẶT

I - NỆP GÓC CẠNH TẮM ỐP (NHỰA PVC + GỖ NGUYÊN SINH)









52	E25	 Model Splins E25 Size: 25*25mm		KT: 25*25 Độ dài thanh: L=2.9m	Nẹp góc cạnh tấm ốp, nguyên sinh	16,308		
53	E40	 Model Splins E40 Size: 40*40mm		KT: 40*40 Độ dài thanh: L=2.9m	Nẹp góc cạnh tấm ốp, nguyên sinh	36,923		
54	E45	 Model Splins E40 Size: 45*45mm		KT: 45*45 Độ dài thanh: L=2.9m	Nẹp góc cạnh tấm ốp, nguyên sinh	46,154		
55	E45CD	 Model Splins E45CD Size: 45*45mm		KT: 45*45 Độ dài thanh: L=2.9m	Nẹp góc cạnh tấm ốp dòng CD có phủ PVDF, nguyên sinh	48,108		

II- NỆP GÓC CẠNH SÀN NGOÀI TRỜI (NHỰA HDPE + GỖ)

56	EW-5050	 Model Splint Decking EW-5050 Size: 50*50mm		KT: 50*50 Độ dài thanh: L=2.9m	Nẹp sàn, nẹp tấm ốp tường HDPE	50,554		
57	EW-55	 Model Splint Decking EW-55 Size: 55*55mm		KT: 50*50 Độ dài thanh: L=2.9m	Nẹp sàn, nẹp tấm ốp tường HDPE	52,308		
III - XƯƠNG LÓT TẤM ỐP, THANH TRANG TRÍ, XƯƠNG LÓT SÀN, KE CHÓT SÀN, KẸP TẤM ỐP								
58	E30H8	 Model Multifunctional E30H8 Size: 30*8mm		KT: 30*8 Độ dài thanh: L=2.9m	Xương lót sàn, tấm ốp	24,462		
59	E32H10			KT: 32*10 Độ dài thanh: L=2.9m	Nẹp góc cạnh tấm ốp, xương tấm ốp, xương sàn ban công	33,846		
60	E40H25	 Model Multifunctional E40H25 Size: 40*25mm		KT: 40*25 Độ dài thanh: L=2.9m	Xương lót sàn	52,185		
61	EKN01	 Model Wall Accessories EKN01 Size: 50*35*2mm		KT: 50*35	Ke Inox - kẹp tấm ốp dùng để liên kết giữa tấm ốp và thanh xương	815		

62	EKN02	 <p>Model: EKN02 Ke chốt sàn Size: 40*20*13mm</p>		KT: 40*20*13	Ke nhựa chốt sàn, dùng để liên kết giữa tấm sàn và thanh đà	652		
----	--------------	--	--	--------------	---	------------	--	--

IV - XƯƠNG CÀI TRẦN NAN, TẤM ÓP ĐA NĂNG

63	E25H25	 <p>Model: E25H25 Accessories Size: 25*25mm</p>		KT: 25*25 Độ dài thanh: L=3m	Thanh xương treo trần nan, chất liệu hợp kim, màu sơn đen - L01: Khoảng cách khe giữa hai thanh gỗ = 4.5cm - L02: Khoảng cách khe giữa hai thanh gỗ = 8cm - L02: Khoảng cách khe giữa hai thanh gỗ = 9cm	35,877		
64	WPO-1003	 <p>Model: WPO-1003 Wall Panel Size: 100*3mm</p>		KT: 100*3 Độ dài thanh: L=2.9m	Thanh gỗ đa năng: Ốp tường, ốp trần trang trí nội ngoại thất	44,031		
65	WPO-904	 <p>Model: WPO-904 Wall Panel Size: 90*4mm</p>		KT: 90*4 Độ dài thanh: L=2.9m	Thanh gỗ đa năng: Ốp tường, ốp trần trang trí nội ngoại thất	44,031		
66	WPO-503	 <p>Model: WPO-503 Wall Panel Size: 50*3mm</p>		KT: 50*3 Độ dài thanh: L=2.9m	Thanh gỗ đa năng: Ốp tường, ốp trần trang trí nội ngoại thất	20,385		

V - PHÀO TRẦN, TƯỜNG

Điều kiện thương mại

1. Giá trên chưa bao gồm 10%VAT.

2. Tạm ứng 50% khi xác nhận ĐDH hoặc ký HĐ. Thanh toán 50% còn lại trước khi giao nhận hàng hóa.

3. Quy định đổi trả hàng:

[Trường hợp do lỗi sản phẩm: Đổi trả trong thời gian 10 ngày, Ecowood chịu chi phí vận chuyển và xếp dỡ.]

[Trường hợp trả lại hàng không do lỗi sản phẩm: Đổi trả trong thời gian 30 ngày.]

_ Ecowood chỉ nhận lại hàng còn mới, nguyên kiện.

_ Số lượng đổi trả tối đa 15%/ tổng số lượng của đơn hàng. Quý khách hàng lưu ý tính đủ hoặc dư thừa tối đa 15% đơn hàng, tránh trường hợp dư thừa quá nhiều.

_ Áp dụng tính phí 10% giá trị đổi trả.

4. Giao nhận hàng tại kho hàng KỶ NGUYỄN XANH

_ Kho: 01 - 03 - 05 Hòa An 18 - Cẩm Lệ - Đà Nẵng

_ Hotline: 0901.828.444 & 0901.232.555

CÔNG TY TNHH ĐT TM & XD KỶ NGUYỄN XANH



CHỦ TỊCH HĐQT
Hà Công Thanh